

# A2503 AMP 2.50 CONNECTOR

2.50mm Pitch/Disconnectable Crimp style connectors

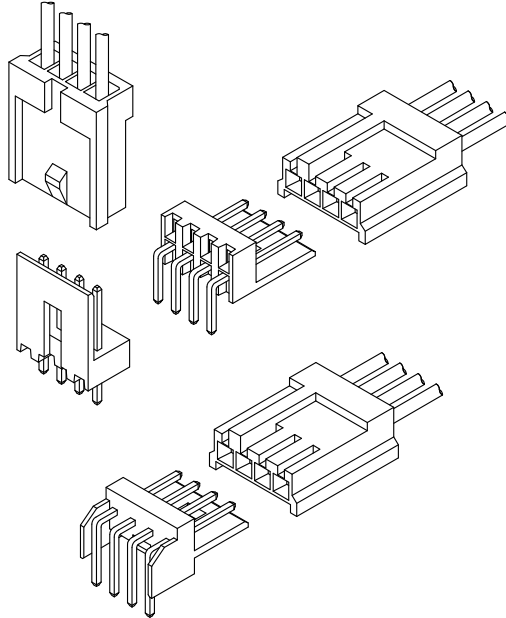

- Secure locking structure
- Low insertion force
- Suction area for picking up
- Improvement of engagement with prying

## Specifications:

- Current rating: 3.0 A / AC,DC (AWG #20)
- Voltage rating: 250 V AC/DC
- Temperature range: -40°C ~ +105°C  
(including temperature rise in applying electrical current)
- Contact resistance: Initial value/ 20m Ω max  
Insulation resistance: 500 M Ω min  
Withstanding voltage: 800 VAC/minute  
Applicable wire: Conductor size/ AWG#26~#20  
Insulation O.D./ 1.00 to 1.90 mm
- \* Compliant with RoHS2/ REACH
- \* Refer to "General Instruction and Notice when using Terminals and Connectors"
- \* Contact CSG for details

Material:

Housing: PA66/UL94-V0;Color:White

Terminal: Phosphor/ Tin-plated

DIP Wafer Housing: PA66,UL94-V0;Color:White

DIP Wafer Pin: Brass/ Tin-plated

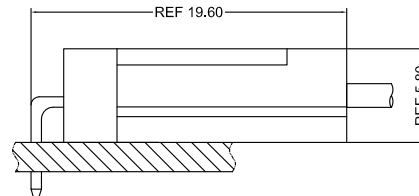
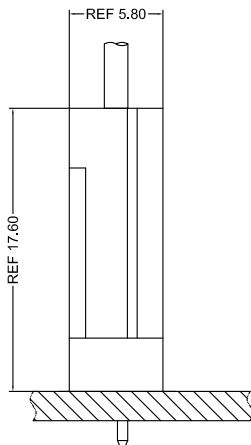

- Note: 1. The above figure is the figure viewed from the connector mounting side.  
2. Tolerances are non-cumulative:  $\pm 0.08$  mm for all centers.  
3. The dimensions above should serve as a guideline. Contact CSG for details.

**CSG**

# A2503 AMP 2.50

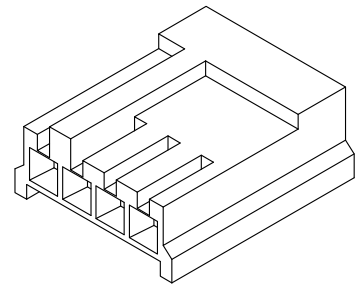
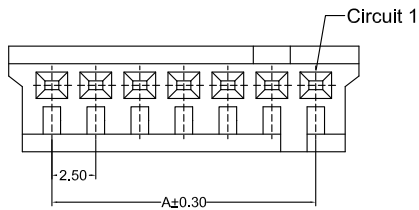
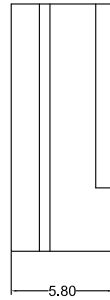
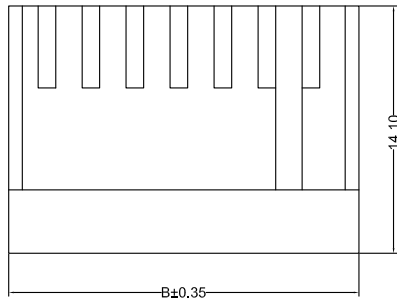

A2503HF 0XX AA P6 9 008  
 PIN  
 005=5PINS  
 SPECIAL  
 AA=NO Special  
 Material  
 P6=PA66 94V-0  
 Code  
 008  
 Color  
 9=White

CSG PART NO.	Dimension mm		Q'ty/BAG
	A	B	
A2503HF003AAP69008	5.00	9.90	1000PCS
A2503HF004AAP69008	7.50	12.40	1000PCS
A2503HF007AAP69008	15.00	19.60	1000PCS
A2503HF012AAP69008	27.50	32.00	1000PCS

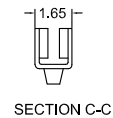
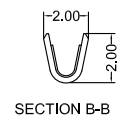
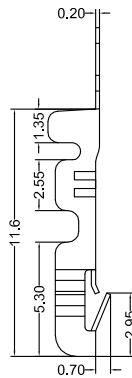
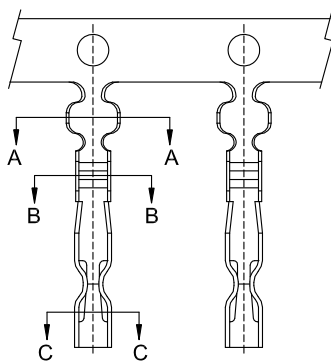

A2503 M O B TP 008  
 Type  
 M=Female Terminal  
 SPECIAL  
 O=NO Special  
 Material  
 B=Bass  
 Finish  
 TP=Tin-Plated  
 Code  
 008

CSG PART NO.	Wire Range	Insulation O.D.	Q'ty/Reel
A2503M0BTP008	AWG#20-#26	1.90mm(max)	10000PCS



# A2503 AMP 2.50

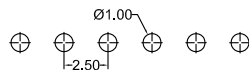
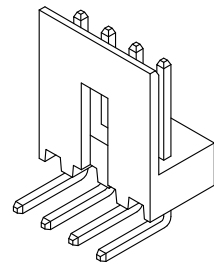
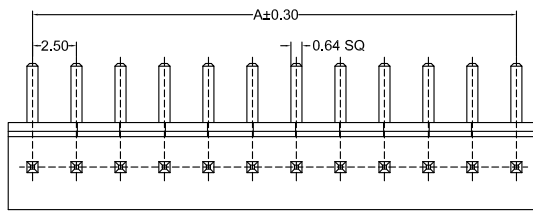
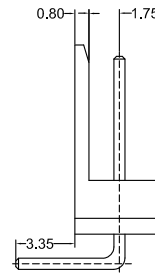
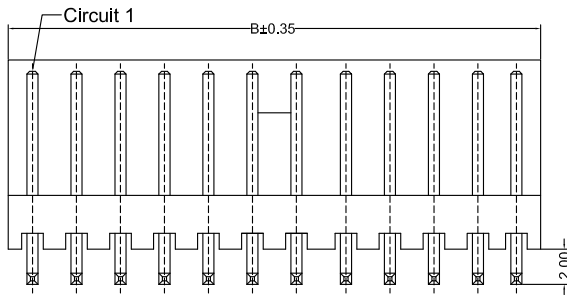

Recommended P.C.B Layout  
General Tolerance±0.05

A2503RD.0XX AA P6 TP C 9 008  
 PIN 002=2PINS  
 SPECIAL AA=NO Special  
 Material P6=PA66 94V-0  
 Finish TP=Terminal Tin-Plated  
 Code 008  
 Color 9=White  
 Packing C=Bag

CSG PART NO.	Dimension mm		Q'ty/BAG
	A	B	
A2503RD003AAP6TPC9008	5.00	10.00	1000PCS
A2503RD004AAP6TPC9008	7.50	12.50	1000PCS
A2503RD007AAP6TPC9008	15.00	19.50	1000PCS
A2503RD012AAP6TPC9008	27.50	32.50	1000PCS

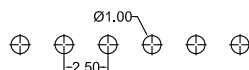
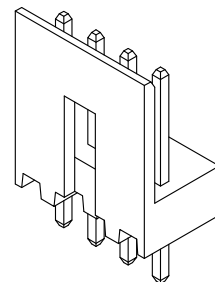
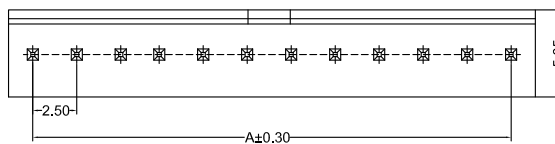
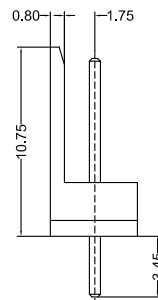
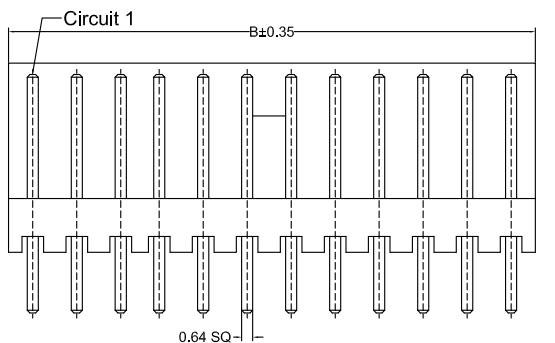

Recommended P.C.B Layout  
General Tolerance±0.05

A2503VD.0XX AA P6 TP C 9 008  
 PIN 002=2PINS  
 SPECIAL AA=NO Special  
 Material P6=PA66 94V-0  
 Finish TP=Terminal Tin-Plated  
 Code 008  
 Color 9=White  
 Packing C=Bag

CSG PART NO.	Dimension mm		Q'ty/BAG
	A	B	
A2503VD003AAP6TPC9008	5.00	10.00	1000PCS
A2503VD004AAP6TPC9008	7.50	12.50	1000PCS
A2503VD007AAP6TPC9008	15.00	19.50	1000PCS
A2503VD012AAP6TPC9008	27.50	32.50	1000PCS

