

# A2542 2510 CONNECTOR

2.54mm Pitch/Disconnectable Crimp style connectors

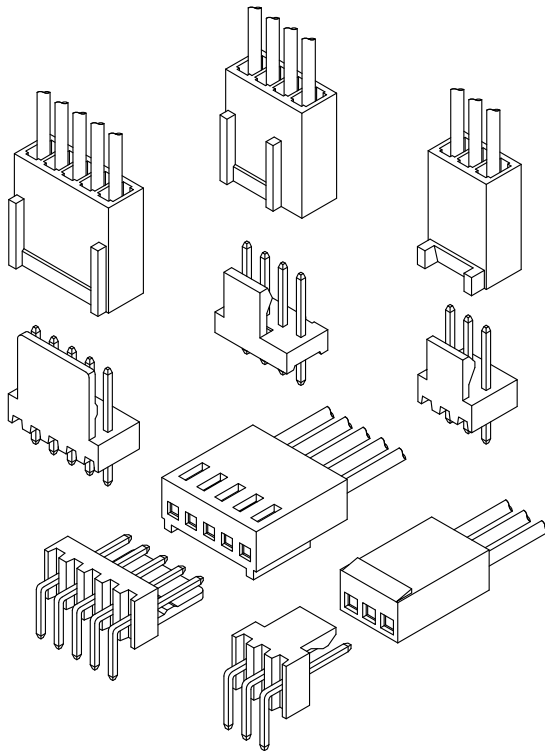

- Secure locking structure
- Low insertion force
- Suction area for picking up
- Improvement of engagement with prying

## Specifications:

- Current rating: 4.0 A / AC,DC (AWG #22)
- Voltage rating: 250 V AC/DC
- Temperature range: -40°C ~ +105°C  
(including temperature rise in applying electrical current)
- Contact resistance: Initial value/ 20m Ω max  
Insulation resistance: 1000 MΩ min  
Withstanding voltage: 1000 VAC/minute  
Applicable wire: Conductor size/ AWG#28~#22  
Insulation O.D./ 0.80 to 1.63 mm

- \* Compliant with RoHS2/ REACH
- \* Refer to "General Instruction and Notice when using Terminals and Connectors"
- \* Contact CSG for details

Material:

Housing: PA66/UL94-V0;Color:

Beige/ White/ Black/ Brown

Terminal: Phosphor/ Gold-Plated/ Tin-plated

DIP Wafer Housing: PA66,UL94-V0;Color:Black/ White/ Beige

DIP Wafer Pin: Brass/ Tin-plated

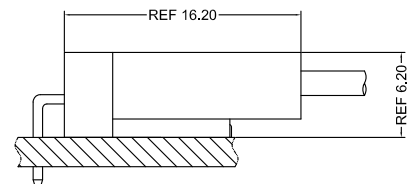
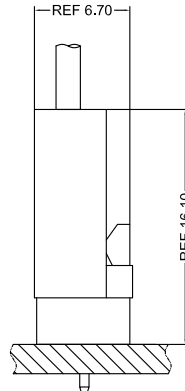
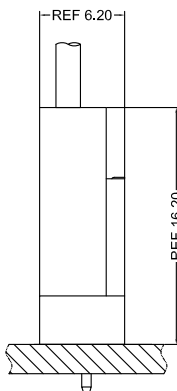

- Note: 1. The above figure is the figure viewed from the connector mounting side.  
2. Tolerances are non-cumulative:  $\pm 0.08$  mm for all centers.  
3. The dimensions above should serve as a guideline. Contact CSG for details.

**CSG**

# A2542 2510

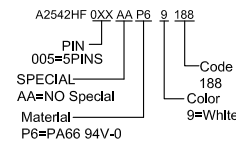
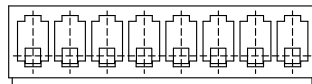
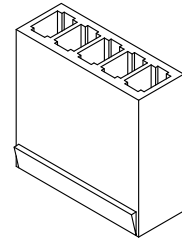
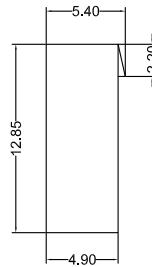
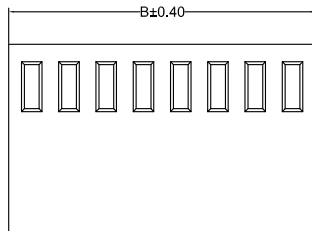
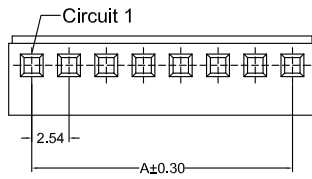

CSG PART NO.	Dimension mm		Q'ty/BAG
	A	B	
A2542HF002AAP69188	2.54	5.68	1000PCS
A2542HF003AAP69188	5.08	8.22	1000PCS
A2542HF004AAP69188	7.62	10.76	1000PCS
A2542HF005AAP69188	10.16	13.30	1000PCS
A2542HF006AAP69188	12.70	15.84	1000PCS
A2542HF007AAP69188	15.24	18.38	1000PCS
A2542HF008AAP69188	17.78	20.92	1000PCS
A2542HF009AAP69188	20.32	23.46	1000PCS
A2542HF010AAP69188	22.86	26.00	1000PCS
A2542HF011AAP69188	25.40	28.54	1000PCS
A2542HF012AAP69188	27.94	31.08	1000PCS
A2542HF013AAP69188	30.48	33.62	1000PCS
A2542HF014AAP69188	33.02	36.16	1000PCS
A2542HF015AAP69188	35.56	38.70	1000PCS
A2542HF016AAP69188	38.10	41.24	1000PCS
A2542HF017AAP69188	40.64	43.78	1000PCS
A2542HF018AAP69188	43.18	46.32	1000PCS
A2542HF019AAP69188	45.72	48.86	1000PCS
A2542HF020AAP69188	48.26	51.40	1000PCS

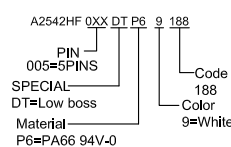
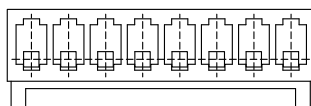
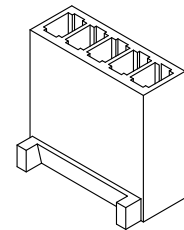
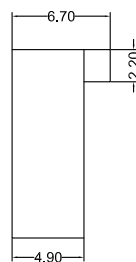
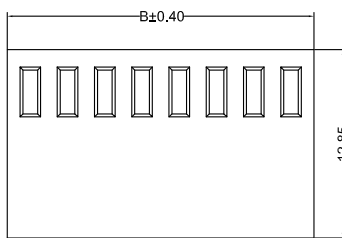
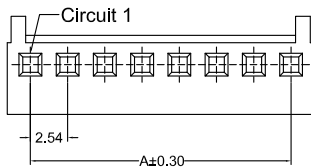

CSG PART NO.	Dimension mm		Q'ty/BAG
	A	B	
A2542HF002DTP69188	2.54	5.68	1000PCS
A2542HF003DTP69188	5.08	8.22	1000PCS
A2542HF004DTP69188	7.62	10.76	1000PCS
A2542HF005DTP69188	10.16	13.30	1000PCS
A2542HF006DTP69188	12.70	15.84	1000PCS
A2542HF007DTP69188	15.24	18.38	1000PCS
A2542HF008DTP69188	17.78	20.92	1000PCS
A2542HF009DTP69188	20.32	23.46	1000PCS
A2542HF010DTP69188	22.86	26.00	1000PCS
A2542HF011DTP69188	25.40	28.54	1000PCS
A2542HF012DTP69188	27.94	31.08	1000PCS
A2542HF013DTP69188	30.48	33.62	1000PCS
A2542HF014DTP69188	33.02	36.16	1000PCS
A2542HF015DTP69188	35.56	38.70	1000PCS
A2542HF016DTP69188	38.10	41.24	1000PCS
A2542HF017DTP69188	40.64	43.78	1000PCS
A2542HF018DTP69188	43.18	46.32	1000PCS
A2542HF019DTP69188	45.72	48.86	1000PCS
A2542HF020DTP69188	48.26	51.40	1000PCS



# A2542 2510

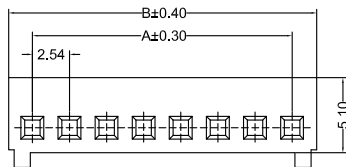
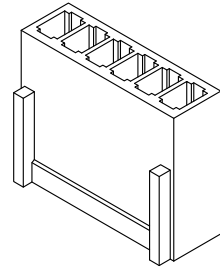
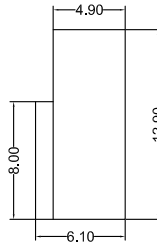
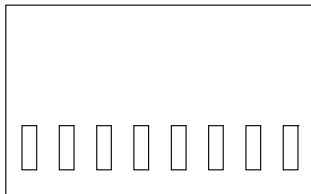
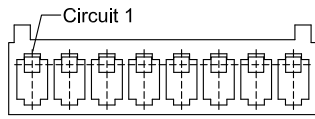

A2542HF 0XX GT P6 X 005  
 PIN 005=5PINS  
 SPECIAL GT=Hight boss  
 Material P6=PA66 94V-0  
 Code 005  
 Color C=Belge 9=White 0=Black

CSG PART NO.	Dimension mm		Q'ty/BAG
	A	B	
A2542HF002GTP6X005	2.54	5.80	1000PCS
A2542HF003GTP6X005	5.08	8.34	1000PCS
A2542HF004GTP6X005	7.62	10.88	1000PCS
A2542HF005GTP6X005	10.16	13.42	1000PCS
A2542HF006GTP6X005	12.70	15.96	1000PCS
A2542HF007GTP6X005	15.24	18.50	1000PCS
A2542HF008GTP6X005	17.78	21.04	1000PCS
A2542HF009GTP6X005	20.32	23.58	1000PCS
A2542HF010GTP6X005	22.86	26.12	1000PCS
A2542HF011GTP6X005	25.40	28.66	1000PCS
A2542HF012GTP6X005	27.94	31.20	1000PCS
A2542HF013GTP6X005	30.48	33.74	1000PCS
A2542HF014GTP6X005	33.02	36.28	1000PCS
A2542HF015GTP6X005	35.56	38.82	1000PCS
A2542HF016GTP6X005	38.10	41.36	1000PCS
A2542HF017GTP6X005	40.64	43.90	1000PCS
A2542HF018GTP6X005	43.18	46.44	1000PCS
A2542HF019GTP6X005	45.72	48.98	1000PCS
A2542HF020GTP6X005	48.26	51.52	1000PCS

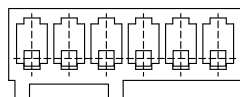
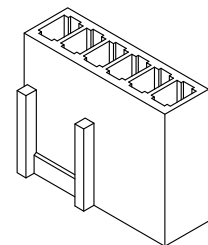
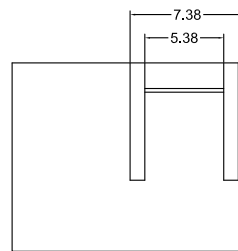
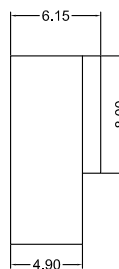
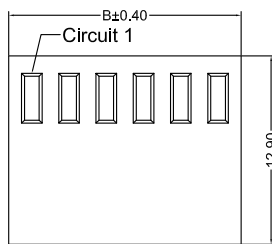
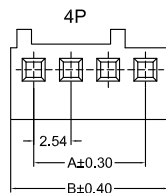
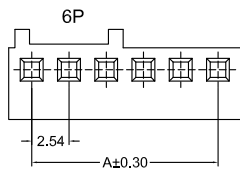

A2542HF 0XX AF P6 X XXX  
 PIN 005=5PINS  
 SPECIAL AF=Assembly  
 Material P6=PA66 94V-0  
 Code 005 188  
 Color 1=Brown 9=White 0=Black

CSG PART NO.	Dimension mm		Q'ty/BAG
	A	B	
A2542HF004AFP6XXXX	7.62	10.76	1000PCS
A2542HF006AFP6XXXX	12.70	15.84	1000PCS



# A2542 2510

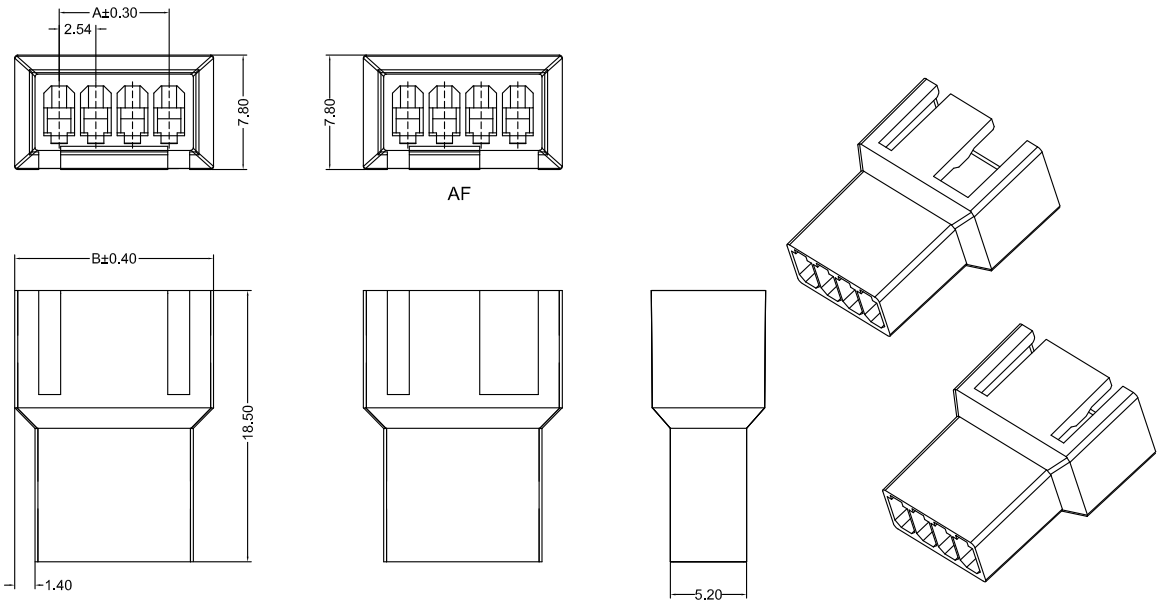

A2542HM 0XX XX P6 X 005

- PIN 005=5PINS
- SPECIAL AA=NO Special AF=Assembly
- Material P6=PA66 94V-0
- Code 005
- Color 1=Brown 9=White 0=Black

CSG PART NO.	Dimension mm		Qty/BAG
	A	B	
A2542HM002AAP6X005	2.54	8.56	1000PCS
A2542HM003AAP6X005	5.08	11.06	1000PCS
A2542HM004AAP6X005	7.62	13.56	1000PCS
A2542HM004AFP6X005	7.62	13.56	1000PCS

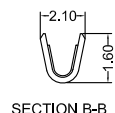
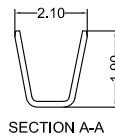
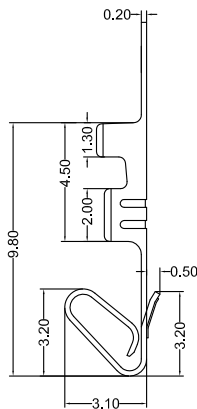
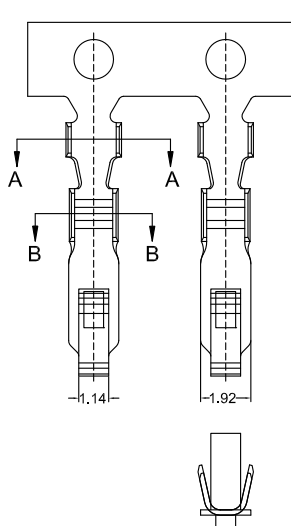

A2542 M 0 A XX 002

- Type M=Female Terminal
- SPECIAL O=NO Special
- Material A=Phosphor
- Finish TP=Tin-Plated GF=Gold-Plated G/F
- Code 002

CSG PART NO.	Wire Range	Insulation O.D.	Qty/Reel
A2542M0ATP002	AWG#22-#28	1.63mm(max)	10000PCS
A2542M0AGF002	AWG#22-#28	1.63mm(max)	10000PCS



# A2542 2510

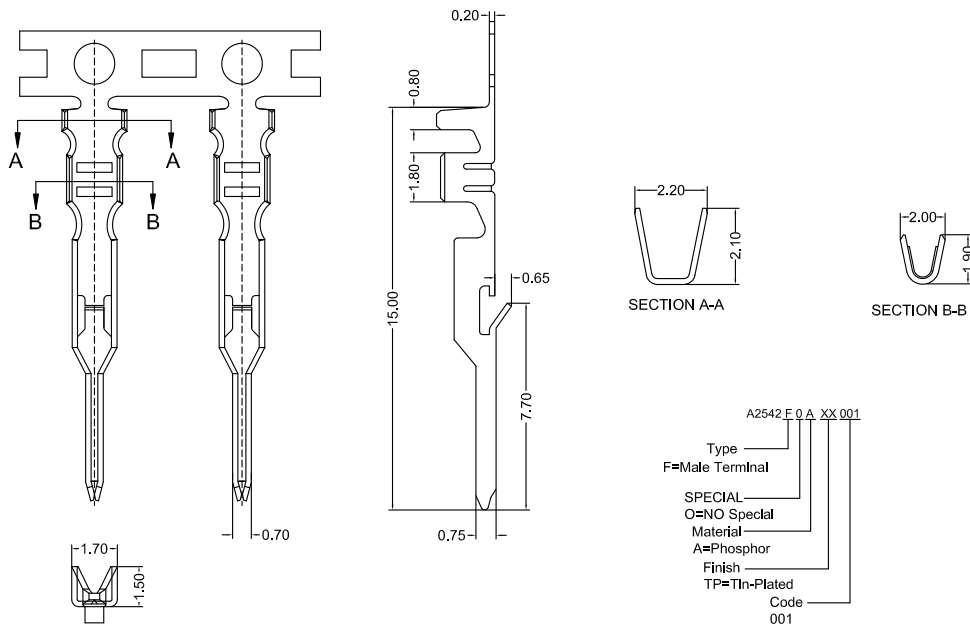

A2542 F 0 A XX 001

Type  
F=Male Terminal

SPECIAL  
O=NO Special

Material  
A=Phosphor

Finish  
TP=Tin-Plated

Code  
001

CSG PART NO.	Wire Range	Insulation O.D.	Q'ty/Reel
A2542F0ATP001	AWG#22-#28	1.63mm(max)	10000PCS

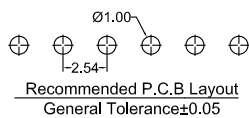
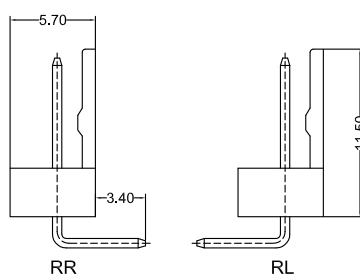
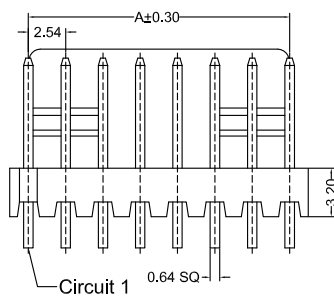
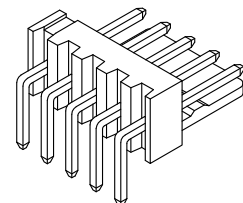
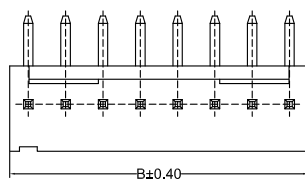

A2542RD\_0XX XX P6 TP C X 008

PIN  
002=2PINS

SPECIAL  
RL=Bending Left  
RR=Bending Rlght

Material  
P6=PA66 94V-0

Finish  
TP=Terminal Tin-Plated

Code  
008

Color  
9=White  
C=Belge

Packing  
C=Bag

CSG PART NO.	Dimension mm		Q'ty/BAG
	A	B	
A2542RD002XXP6TPCX008	2.54	5.08	1000PCS
A2542RD003XXP6TPCX008	5.08	7.62	1000PCS
A2542RD004XXP6TPCX008	7.62	10.16	1000PCS
A2542RD005XXP6TPCX008	10.16	12.70	1000PCS
A2542RD006XXP6TPCX008	12.70	15.24	1000PCS
A2542RD007XXP6TPCX008	15.24	17.78	1000PCS
A2542RD008XXP6TPCX008	17.78	20.32	1000PCS
A2542RD009XXP6TPCX008	20.32	22.86	1000PCS
A2542RD010XXP6TPCX008	22.86	25.40	1000PCS
A2542RD011XXP6TPCX008	25.40	27.94	1000PCS
A2542RD012XXP6TPCX008	27.94	30.48	1000PCS
A2542RD013XXP6TPCX008	30.48	33.02	1000PCS
A2542RD014XXP6TPCX008	33.02	35.56	1000PCS
A2542RD015XXP6TPCX008	35.56	38.10	1000PCS
A2542RD016XXP6TPCX008	38.10	40.64	1000PCS
A2542RD017XXP6TPCX008	40.64	43.18	1000PCS
A2542RD018XXP6TPCX008	43.18	45.72	1000PCS
A2542RD019XXP6TPCX008	45.72	48.26	1000PCS
A2542RD020XXP6TPCX008	48.26	50.80	1000PCS



# A2542 2510

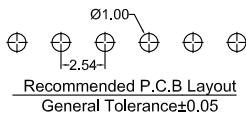
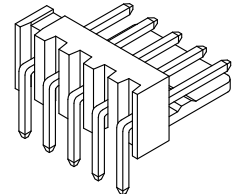
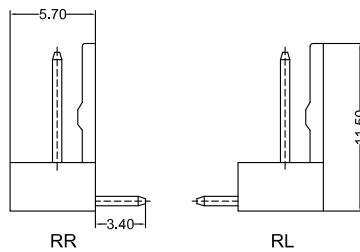
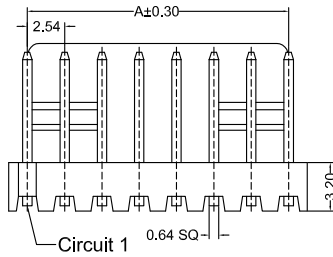
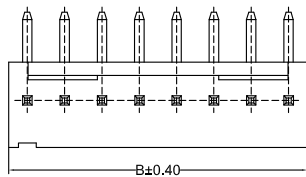

A2542RD\_0XX XX P6 TP C X 007

PIN  
002=2PINS

SPECIAL  
RL=Bending Left  
RR=Bending Right

Material  
P6=PA66 94V-0

Finish  
TP=Terminal Tin-Plated

Code  
007

Color  
9=White  
C=Beige

Packing  
C=Bag

CSG PART NO.	Dimension mm		Q'ty/BAG
	A	B	
A2542RD002XXP6TPCX007	2.54	5.08	1000PCS
A2542RD003XXP6TPCX007	5.08	7.62	1000PCS
A2542RD004XXP6TPCX007	7.62	10.16	1000PCS
A2542RD005XXP6TPCX007	10.16	12.70	1000PCS
A2542RD006XXP6TPCX007	12.70	15.24	1000PCS
A2542RD007XXP6TPCX007	15.24	17.78	1000PCS
A2542RD008XXP6TPCX007	17.78	20.32	1000PCS
A2542RD009XXP6TPCX007	20.32	22.86	1000PCS
A2542RD010XXP6TPCX007	22.86	25.40	1000PCS
A2542RD011XXP6TPCX007	25.40	27.94	1000PCS
A2542RD012XXP6TPCX007	27.94	30.48	1000PCS
A2542RD013XXP6TPCX007	30.48	33.02	1000PCS
A2542RD014XXP6TPCX007	33.02	35.56	1000PCS
A2542RD015XXP6TPCX007	35.56	38.10	1000PCS
A2542RD016XXP6TPCX007	38.10	40.64	1000PCS
A2542RD017XXP6TPCX007	40.64	43.18	1000PCS
A2542RD018XXP6TPCX007	43.18	45.72	1000PCS
A2542RD019XXP6TPCX007	45.72	48.26	1000PCS
A2542RD020XXP6TPCX007	48.26	50.80	1000PCS

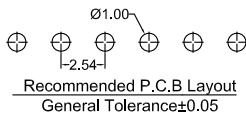
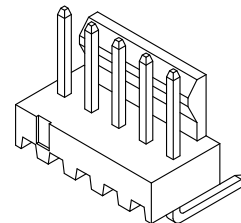
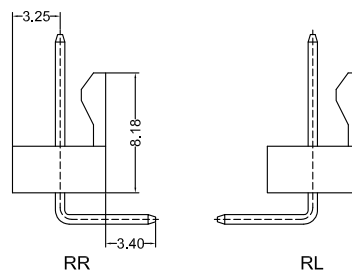
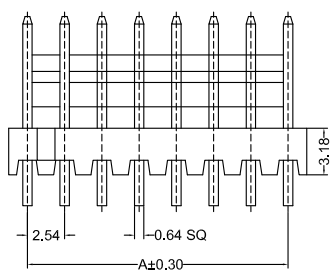
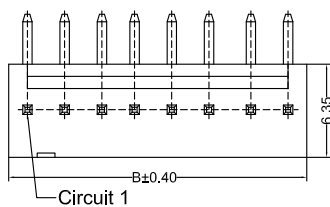

A2542RD\_0XX XX P6 TP C X 188

PIN  
002=2PINS

SPECIAL  
RL=Bending Left  
RR=Bending Right

Material  
P6=PA66 94V-0

Finish  
TP=Terminal Tin-Plated

Code  
188

Color  
9=White  
0=Black

Packing  
C=Bag

CSG PART NO.	Dimension mm		Q'ty/BAG
	A	B	
A2542RD002XXP6TPCX188	2.54	5.08	1000PCS
A2542RD003XXP6TPCX188	5.08	7.62	1000PCS
A2542RD004XXP6TPCX188	7.62	10.16	1000PCS
A2542RD005XXP6TPCX188	10.16	12.70	1000PCS
A2542RD006XXP6TPCX188	12.70	15.24	1000PCS
A2542RD007XXP6TPCX188	15.24	17.78	1000PCS
A2542RD008XXP6TPCX188	17.78	20.32	1000PCS
A2542RD009XXP6TPCX188	20.32	22.86	1000PCS
A2542RD010XXP6TPCX188	22.86	25.40	1000PCS
A2542RD011XXP6TPCX188	25.40	27.94	1000PCS
A2542RD012XXP6TPCX188	27.94	30.48	1000PCS
A2542RD013XXP6TPCX188	30.48	33.02	1000PCS
A2542RD014XXP6TPCX188	33.02	35.56	1000PCS
A2542RD015XXP6TPCX188	35.56	38.10	1000PCS
A2542RD016XXP6TPCX188	38.10	40.64	1000PCS
A2542RD017XXP6TPCX188	40.64	43.18	1000PCS
A2542RD018XXP6TPCX188	43.18	45.72	1000PCS
A2542RD019XXP6TPCX188	45.72	48.26	1000PCS
A2542RD020XXP6TPCX188	48.26	50.80	1000PCS



# A2542 2510

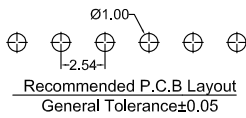
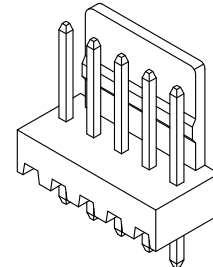
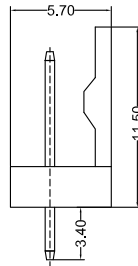
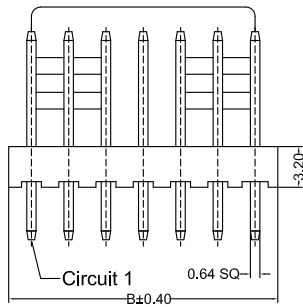
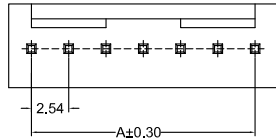

A2542VD\_0XX AA P6 TP C X 008

- PIN 002=2PINS
- SPECIAL AA=NO Special
- Material P6=PA66 94V-0
- Finish TP=Terminal Tin-Plated
- Code 008
- Color 9=White C=Beige
- Packing C=Bag

CSG PART NO.	Dimension mm		Q'ty/BAG
	A	B	
A2542VD002AAP6TPCX008	2.54	5.08	1000PCS
A2542VD003AAP6TPCX008	5.08	7.62	1000PCS
A2542VD004AAP6TPCX008	7.62	10.16	1000PCS
A2542VD005AAP6TPCX008	10.16	12.70	1000PCS
A2542VD006AAP6TPCX008	12.70	15.24	1000PCS
A2542VD007AAP6TPCX008	15.24	17.18	1000PCS
A2542VD008AAP6TPCX008	17.18	20.32	1000PCS
A2542VD009AAP6TPCX008	20.32	22.86	1000PCS
A2542VD010AAP6TPCX008	22.86	25.40	1000PCS
A2542VD011AAP6TPCX008	25.40	27.94	1000PCS
A2542VD012AAP6TPCX008	27.94	30.48	1000PCS
A2542VD013AAP6TPCX008	30.48	33.02	1000PCS
A2542VD014AAP6TPCX008	33.02	35.56	1000PCS
A2542VD015AAP6TPCX008	35.56	38.10	1000PCS
A2542VD016AAP6TPCX008	38.10	40.64	1000PCS
A2542VD017AAP6TPCX008	40.64	43.18	1000PCS
A2542VD018AAP6TPCX008	43.18	45.72	1000PCS
A2542VD019AAP6TPCX008	45.72	48.26	1000PCS
A2542VD020AAP6TPCX008	48.26	50.80	1000PCS

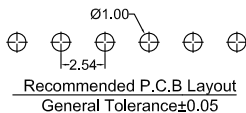
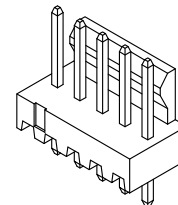
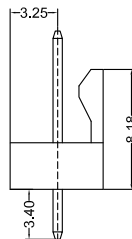
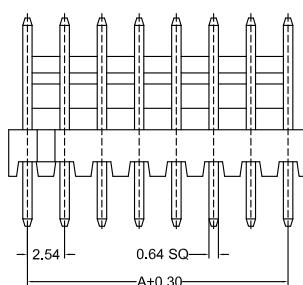
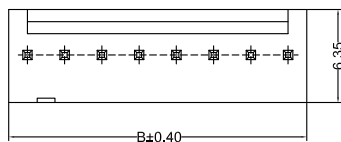

A2542VD\_0XX AA P6 TP C X 188

- PIN 002=2PINS
- SPECIAL AA=NO Special
- Material P6=PA66 94V-0
- Finish TP=Terminal Tin-Plated
- Code 188
- Color 0=Black
- Packing C=Bag

CSG PART NO.	Dimension mm		Q'ty/BAG
	A	B	
A2542VD002AAP6TPCX188	2.54	5.08	1000PCS
A2542VD003AAP6TPCX188	5.08	7.62	1000PCS
A2542VD004AAP6TPCX188	7.62	10.16	1000PCS
A2542VD005AAP6TPCX188	10.16	12.70	1000PCS
A2542VD006AAP6TPCX188	12.70	15.24	1000PCS
A2542VD007AAP6TPCX188	15.24	17.18	1000PCS
A2542VD008AAP6TPCX188	17.18	20.32	1000PCS
A2542VD009AAP6TPCX188	20.32	22.86	1000PCS
A2542VD010AAP6TPCX188	22.86	25.40	1000PCS
A2542VD011AAP6TPCX188	25.40	27.94	1000PCS
A2542VD012AAP6TPCX188	27.94	30.48	1000PCS
A2542VD013AAP6TPCX188	30.48	33.02	1000PCS
A2542VD014AAP6TPCX188	33.02	35.56	1000PCS
A2542VD015AAP6TPCX188	35.56	38.10	1000PCS
A2542VD016AAP6TPCX188	38.10	40.64	1000PCS
A2542VD017AAP6TPCX188	40.64	43.18	1000PCS
A2542VD018AAP6TPCX188	43.18	45.72	1000PCS
A2542VD019AAP6TPCX188	45.72	48.26	1000PCS
A2542VD020AAP6TPCX188	48.26	50.80	1000PCS

