

A2502 EH CONNECTOR

2.50mm Pitch/Disconnectable Crimp style connectors

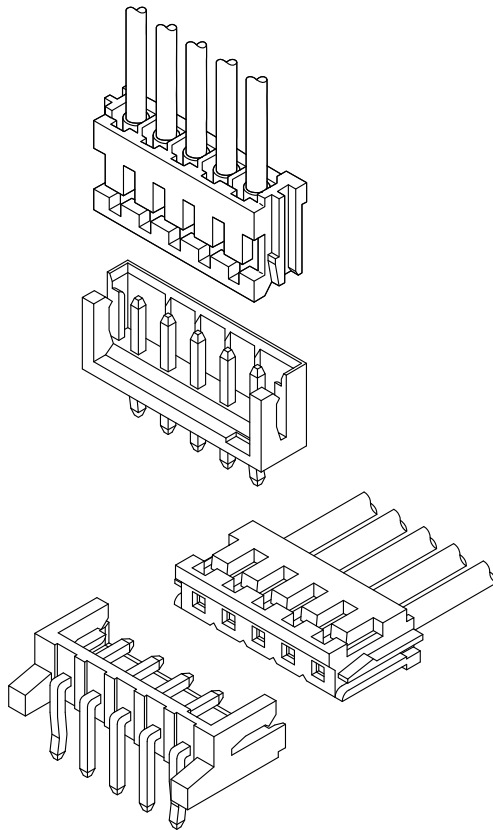

- Secure locking structure
- Low insertion force
- Suction area for picking up
- Improvement of engagement with prying

Specifications:

- Current rating: 3.0 A / AC,DC (AWG #22)
- Voltage rating: 250 V AC/DC
- Temperature range: -40°C ~ +105°C
(including temperature rise in applying electrical current)
- Contact resistance: Initial value/ 20m Ω max
Insulation resistance: 1000 M Ω min
Withstanding voltage: 800 VAC/minute
Applicable wire: Conductor size/ AWG#28~#22
Insulation O.D./ 0.80 to 1.90 mm

- * Compliant with RoHS2/ HF/ REACH
- * Refer to "General Instruction and Notice when using Terminals and Connectors"
- * Contact CSG for details

Material:

Housing: PA66/UL94-V0;Color:White

Terminal: Phosphor/ Tin-plated

DIP Wafer Housing: PA66,UL94-V0;Color:White

DIP Wafer Pin: Brass/ Tin-plated

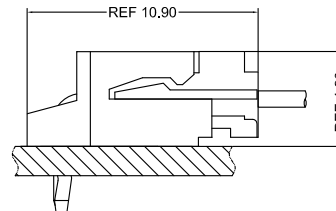
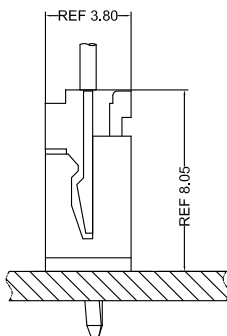

- Note: 1. The above figure is the figure viewed from the connector mounting side.
2. Tolerances are non-cumulative: ± 0.08 mm for all centers.
3. The dimensions above should serve as a guideline. Contact CSG for details.

CSG

A2502 EH

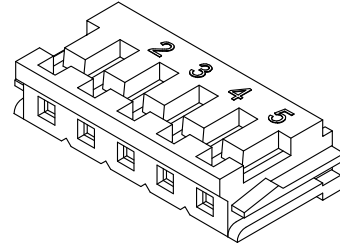
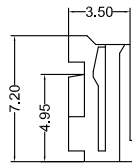
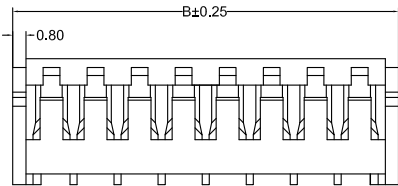
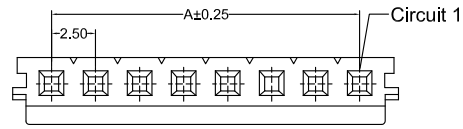

A2502HF 0XX AA P6 9 007

PIN
005=5PINS

SPECIAL:
AA=NO Special

Material
P6=PA66 94V-0

Code
007

Color
9=White

| CSG PART NO. | Dimension mm | | Qty/BAG |
|--------------------|--------------|-------|---------|
| | A | B | |
| A2502HF002AAP69007 | 2.50 | 7.00 | 1000PCS |
| A2502HF003AAP69007 | 5.00 | 9.50 | 1000PCS |
| A2502HF004AAP69007 | 7.50 | 12.00 | 1000PCS |
| A2502HF005AAP69007 | 10.00 | 14.50 | 1000PCS |
| A2502HF006AAP69007 | 12.50 | 17.00 | 1000PCS |
| A2502HF007AAP69007 | 15.00 | 19.50 | 1000PCS |
| A2502HF008AAP69007 | 17.50 | 22.00 | 1000PCS |
| A2502HF009AAP69007 | 20.00 | 24.50 | 1000PCS |
| A2502HF010AAP69007 | 22.50 | 27.00 | 1000PCS |
| A2502HF011AAP69007 | 25.00 | 29.50 | 1000PCS |
| A2502HF012AAP69007 | 27.50 | 32.00 | 1000PCS |
| A2502HF013AAP69007 | 30.00 | 34.50 | 1000PCS |
| A2502HF014AAP69007 | 32.50 | 37.00 | 1000PCS |
| A2502HF015AAP69007 | 35.00 | 39.50 | 1000PCS |

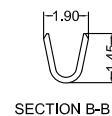
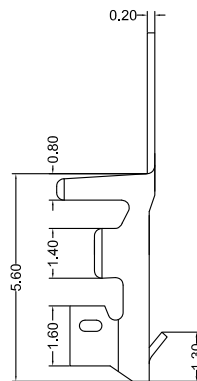
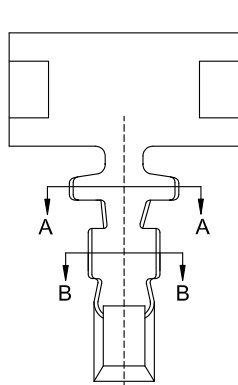

A2502 M 0 A TP 007

Type
M=Female Terminal

SPECIAL
O=NO Special

Material
A=Phosphor

Finish
TP=Tin-Plated

Code
007

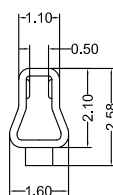

| CSG PART NO. | Wire Range | Insulation O.D. | Qty/Reel |
|---------------|------------|-----------------|----------|
| A2502M0ATP007 | AWG#22-#28 | 1.90mm(max) | 10000PCS |

A2502 EH

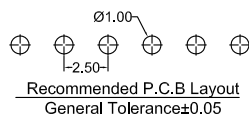
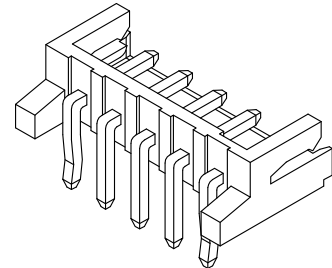
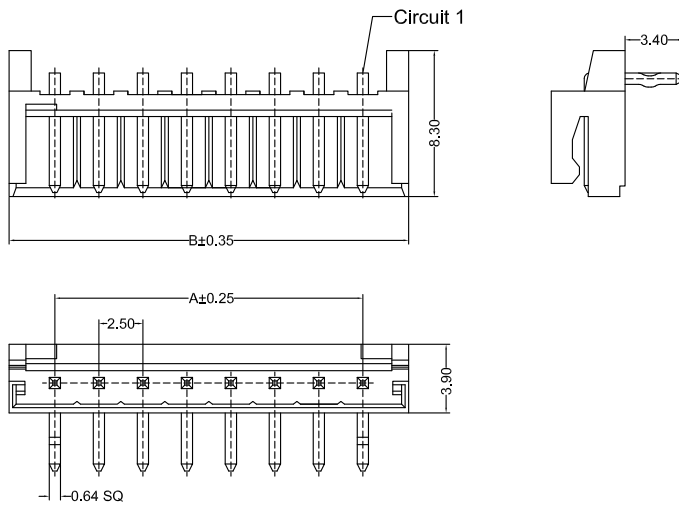

A2502RD.0XX PK P6 TP C 9 007

- PIN 002=2PINS
- SPECIAL PK=Orientation K
- Material P6=PA66 94V-0
- Finish TP=Terminal Tin-Plated
- Code 007
- Color 9=White
- Packing C=Bag

| CSG PART NO. | Dimension mm | | Qty/BAG |
|-----------------------|--------------|-------|---------|
| | A | B | |
| A2502RD002PKP6TPC9007 | 2.50 | 7.50 | 1000PCS |
| A2502RD003PKP6TPC9007 | 5.00 | 10.00 | 1000PCS |
| A2502RD004PKP6TPC9007 | 7.50 | 12.50 | 1000PCS |
| A2502RD005PKP6TPC9007 | 10.00 | 15.00 | 1000PCS |
| A2502RD006PKP6TPC9007 | 12.50 | 17.50 | 1000PCS |
| A2502RD007PKP6TPC9007 | 15.00 | 20.00 | 1000PCS |
| A2502RD008PKP6TPC9007 | 17.50 | 22.50 | 1000PCS |
| A2502RD009PKP6TPC9007 | 20.00 | 25.00 | 1000PCS |
| A2502RD010PKP6TPC9007 | 22.50 | 27.50 | 1000PCS |
| A2502RD011PKP6TPC9007 | 25.00 | 30.00 | 1000PCS |
| A2502RD012PKP6TPC9007 | 27.50 | 32.50 | 1000PCS |
| A2502RD013PKP6TPC9007 | 30.00 | 35.00 | 1000PCS |
| A2502RD014PKP6TPC9007 | 32.50 | 37.50 | 1000PCS |
| A2502RD015PKP6TPC9007 | 35.00 | 40.00 | 1000PCS |

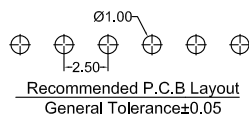
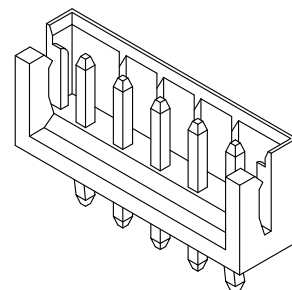
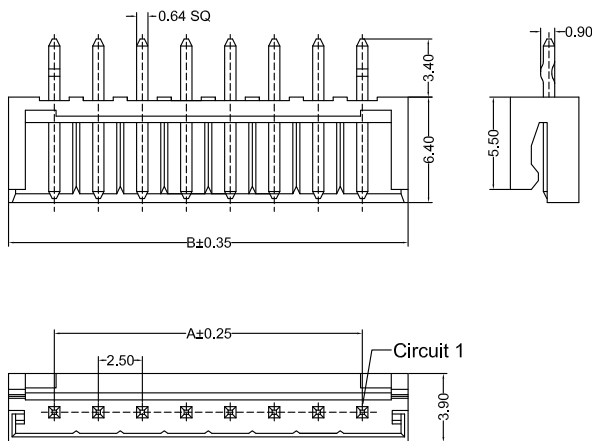

A2502VD.0XX AK P6 TP C 9 007

- PIN 002=2PINS
- SPECIAL AK=K Feet
- Material P6=PA66 94V-0
- Finish TP=Terminal Tin-Plated
- Code 007
- Color 9=White
- Packing C=Bag

| CSG PART NO. | Dimension mm | | Qty/BAG |
|-----------------------|--------------|-------|---------|
| | A | B | |
| A2502VD002AKP6TPC9007 | 2.50 | 7.50 | 1000PCS |
| A2502VD003AKP6TPC9007 | 5.00 | 10.00 | 1000PCS |
| A2502VD004AKP6TPC9007 | 7.50 | 12.50 | 1000PCS |
| A2502VD005AKP6TPC9007 | 10.00 | 15.00 | 1000PCS |
| A2502VD006AKP6TPC9007 | 12.50 | 17.50 | 1000PCS |
| A2502VD007AKP6TPC9007 | 15.00 | 20.00 | 1000PCS |
| A2502VD008AKP6TPC9007 | 17.50 | 22.50 | 1000PCS |
| A2502VD009AKP6TPC9007 | 20.00 | 25.00 | 1000PCS |
| A2502VD010AKP6TPC9007 | 22.50 | 27.50 | 1000PCS |
| A2502VD011AKP6TPC9007 | 25.00 | 30.00 | 1000PCS |
| A2502VD012AKP6TPC9007 | 27.50 | 32.50 | 1000PCS |
| A2502VD013AKP6TPC9007 | 30.00 | 35.00 | 1000PCS |
| A2502VD014AKP6TPC9007 | 32.50 | 37.50 | 1000PCS |
| A2502VD015AKP6TPC9007 | 35.00 | 40.00 | 1000PCS |