

A1258 GH CONNECTOR

1.25mm Pitch/Disconnectable Crimp style connectors

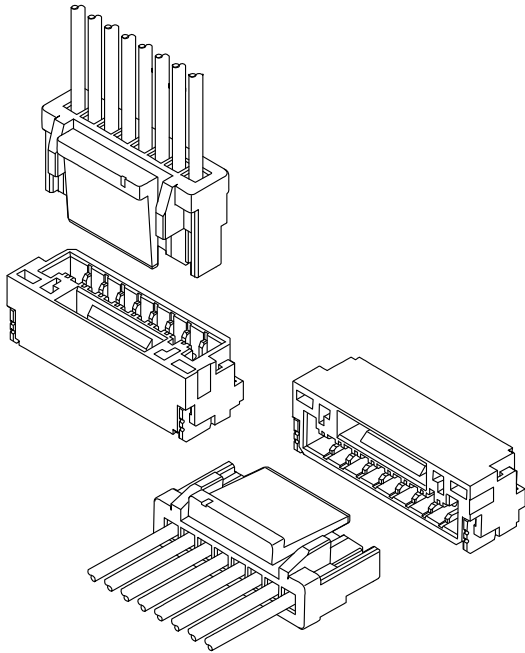

 E529482

Specifications:

- Current rating: 1.5 A / AC,DC
- Voltage rating: 150 V AC/DC
- Temperature range: -25°C ~ +105°C
(including temperature rise in applying electrical current)
- Contact resistance: Initial value/ 30m Ω max
Insulation resistance: 300 M Ω min
Withstanding voltage: 500 VAC/minute
Applicable wire: Conductor size/ AWG#30~#26
Insulation O.D./ 0.50 to 1.00 mm
- * Compliant with RoHS2/ REACH/ HF
- * Refer to "General Instruction and Notice when using Terminals and Connectors"
- * Contact CSG for details

Material:

Housing: PA66/UL94-V0;Color:White
Terminal: Phosphor/ Tin-plated
SMT Wafer Housing: LCP,UL94-V0;Color:Natural
SMT Wafer Pin: Phosphor/ Tin-plated,Gold-Plated
Wafer Fixed Foot: Phosphor/ Tin-plated

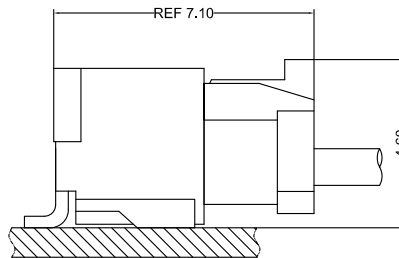
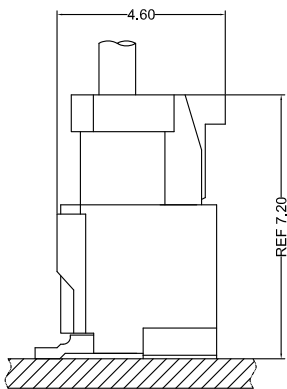

- Note: 1. The above figure is the figure viewed from the connector mounting side.
2. Tolerances are non-cumulative: ± 0.08 mm for all centers.
3. The dimensions above should serve as a guideline. Contact CSG for details.

CSG

A1258 GH

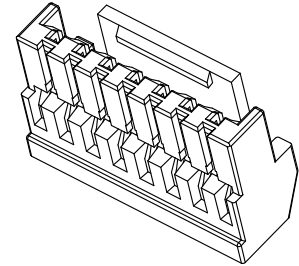
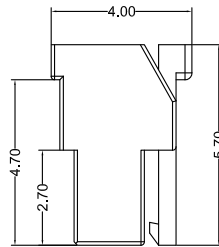
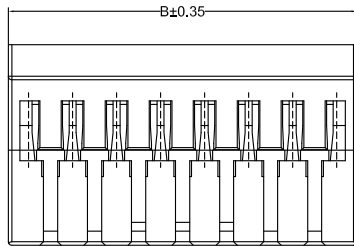
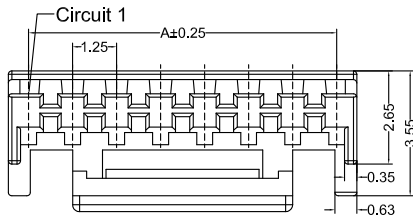

A1258HF 0XX AK P6 9 013

005=5PINS
PIN
SPECIAL
AK=BUCKLE
Material
P6=PA66 94V-0

Code
013
Color
9=White

CSG PART NO.	Dimension mm		Qty/BAG
	A	B	
A1258HF002AKP69013	1.25	3.65	1000PCS
A1258HF003AKP69013	2.50	4.90	1000PCS
A1258HF004AKP69013	3.75	6.15	1000PCS
A1258HF005AKP69013	5.00	7.40	1000PCS
A1258HF006AKP69013	6.25	8.65	1000PCS
A1258HF007AKP69013	7.50	9.90	1000PCS
A1258HF008AKP69013	8.75	11.15	1000PCS
A1258HF009AKP69013	10.00	12.40	1000PCS
A1258HF010AKP69013	11.25	13.65	1000PCS
A1258HF011AKP69013	12.50	14.90	1000PCS
A1258HF012AKP69013	13.75	16.15	1000PCS
A1258HF013AKP69013	15.00	17.40	1000PCS
A1258HF014AKP69013	16.25	18.65	1000PCS
A1258HF015AKP69013	17.50	19.90	1000PCS

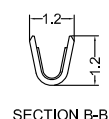
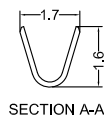
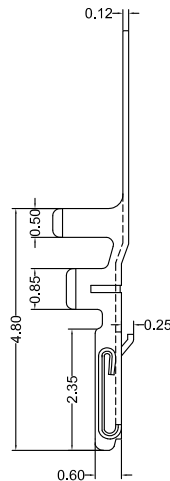
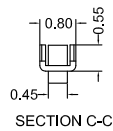
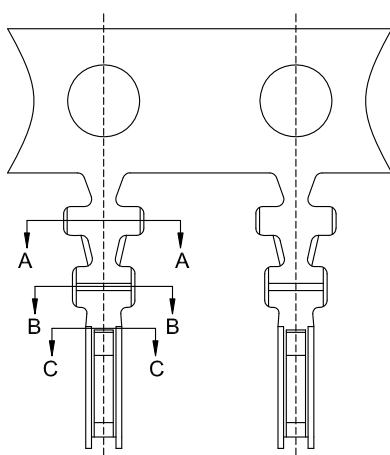

A1258 M 0 XX 013

Type
M=Female Terminal

Material
A=Phosphor

Finish
TP=Tin-Plated

Code
013

CSG PART NO.	Wire Range	Insulation O.D.	Qty/Reel
A1258M0ATP013	AWG#26-#30	1.00mm(max)	15000PCS



A1258 GH

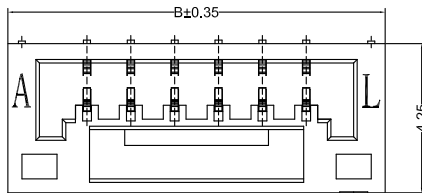
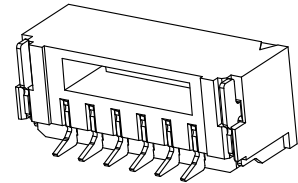
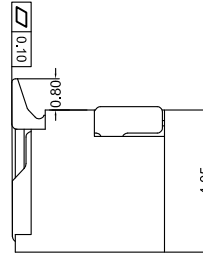
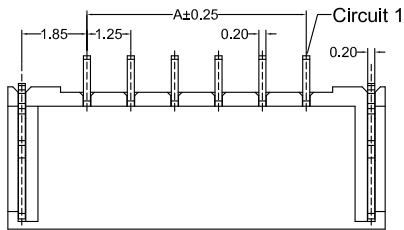

A1258RS_0XX AA LP XX B A 112

PIN
005=5PINS
SPECIAL
AA=NO Special
Material
LP=LCP 94V-0
Finish
TP=Terminal Tin-Plated
GF=Terminal Gold-Plated

Code
112
Color
A=Natural
Packing
B=Tape & Reel

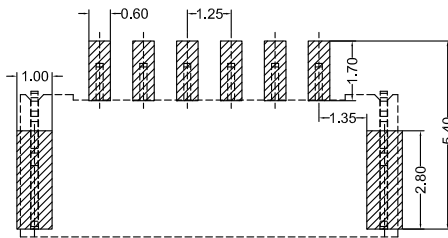

Recommended P.C.B Layout
General Tolerance±0.05

CSG PART NO.	Dimension mm		Q'ty/Reel
	A	B	
A1258RS002AALPXXBA112	1.25	5.75	1000PCS
A1258RS003AALPXXBA112	2.50	7.00	1000PCS
A1258RS004AALPXXBA112	3.75	8.25	1000PCS
A1258RS005AALPXXBA112	5.00	9.50	1000PCS
A1258RS006AALPXXBA112	6.25	10.75	1000PCS
A1258RS007AALPXXBA112	7.50	12.00	1000PCS
A1258RS008AALPXXBA112	8.75	13.25	1000PCS
A1258RS009AALPXXBA112	10.00	14.50	1000PCS
A1258RS010AALPXXBA112	11.25	15.75	1000PCS
A1258RS011AALPXXBA112	12.50	17.00	1000PCS
A1258RS012AALPXXBA112	13.75	18.25	1000PCS
A1258RS013AALPXXBA112	15.00	19.50	1000PCS
A1258RS014AALPXXBA112	16.25	20.75	1000PCS
A1258RS015AALPXXBA112	17.50	22.00	1000PCS

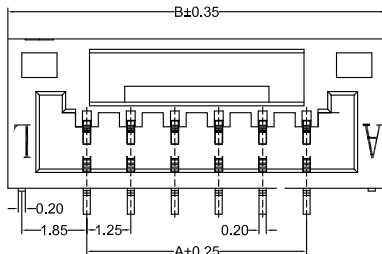

A1258VS_0XX AA LP XX B A 112

PIN
005=5PINS
SPECIAL
AA=NO Special
Material
LP=LCP 94V-0
Finish
TP=Terminal Tin-Plated
GF=Terminal Gold-Plated

Code
112
Color
A=Natural
Packing
B=Tape & Reel

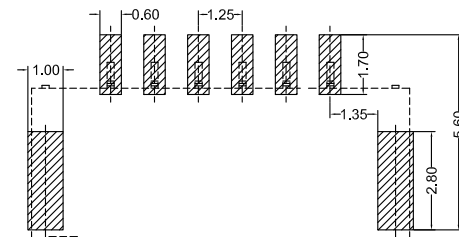
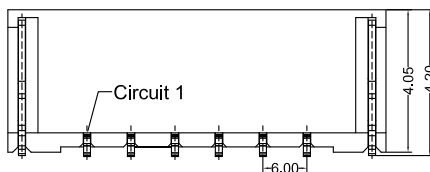
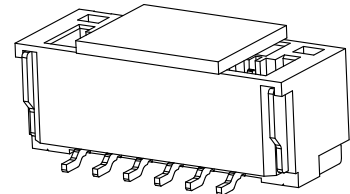

Recommended P.C.B Layout
General Tolerance±0.05

CSG PART NO.	Dimension mm		Q'ty/Reel
	A	B	
A1258VS002AALPXXBA112	1.25	5.75	1000PCS
A1258VS003AALPXXBA112	2.50	7.00	1000PCS
A1258VS004AALPXXBA112	3.75	8.25	1000PCS
A1258VS005AALPXXBA112	5.00	9.50	1000PCS
A1258VS006AALPXXBA112	6.25	10.75	1000PCS
A1258VS007AALPXXBA112	7.50	12.00	1000PCS
A1258VS008AALPXXBA112	8.75	13.25	1000PCS
A1258VS009AALPXXBA112	10.00	14.50	1000PCS
A1258VS010AALPXXBA112	11.25	15.75	1000PCS
A1258VS011AALPXXBA112	12.50	17.00	1000PCS
A1258VS012AALPXXBA112	13.75	18.25	1000PCS
A1258VS013AALPXXBA112	15.00	19.50	1000PCS
A1258VS014AALPXXBA112	16.25	20.75	1000PCS
A1258VS015AALPXXBA112	17.50	22.00	1000PCS

